

6900 Cantilever Liquid Level Control

Application

The Cantilever liquid level control series offers design simplicity, easy installation, adjustment, and reliable liquid level monitoring. It is a highly efficient device for the control of liquid level in oil and gas production equipment such as: separators, dehydrators, and treaters, as well as in manufacturing plants, hazardous waste disposal, food processing, water treatment, petro-chemical facilities, or wherever fluid levels need to be monitored or controlled. The sensing element design, with no moving parts exposed to the tank or vessel fluid, makes the simple installation of the control possible in various standard pipe closures such as: ANSI flanges and grooved, or union, connections. The sensing element has a selection of three control head options that control pneumatic supply to control valves, alarm systems, pressure switches, solenoids, and relays, all of which may be used in response to liquid level changes. These control options are:

Throttling

This throttling control head assembly provides a proportional output pressure signal as changes in vessel liquid levels are sensed by the displacers and transmitted by the sensing rod. Constant vessel liquid level can be maintained when the control outlet is connected with a properly sized pneumatic, diaphragm activated control valve. Sensing adjustment is controlled by an external adjusting screw.

Snap Action

The snap action control head assembly provides on/off supply pressure at a specific liquid level set point established by the displacer setting. This on/off signal can be used to power pressure switches, start-up or shut-down controls, alarms, or pneumatic diaphragm activated control valves to open or close system flow lines.

Features

- Industry Standard
- Design Simplicity
- Optional Pilot Head
 - Throttle or Snap Acting
- Optional Process Connections – See Chart
- Optional Choice of Sensing Rod – See Chart
- Optional Choice of Displacer – See Chart
- Optional Low-Bleed MIZER® – See Chart



Specifications

Max. Working Pressure	1500 psi
Operating Temperature	-20°F or +200°F (higher temperature available)
Process Connections	See Chart
Pilot Connections	1/4" FNPT
Supply Pressure	20 psi Minimum-30 psi Maximum (limited by pressure gauge)
Output Pressure	3-15 psi – Throttle 0-Full Supply – Snap (Pilot good to 75 psi)

Materials

Displacer	See Chart
Process Connection	Carbon Steel
Sight Glass	Polycarbonate
Sensing Rod	316 S.S.
Seals	Buna-N Standard (others available)
Hammer Union Ring	4" and 5" WCB Others Fabricated Carbon Steel

WARNING

If supply gas is flammable or noxious, this product **MUST** be located in a well ventilated non-hazardous area or sealed and vented to a non-hazardous area.

6900 Cantilever Liquid Level Control

Principle of Operation

This liquid level control operates on the basis of two basic physical laws:

1. "A solid, heavier than a fluid (a displacer/s) will, if placed in it, descend to the bottom of the fluid, and the solid will, when weighed in the fluid, be lighter than its true weight by the weight of the fluid displaced." —Archimedes' Principal
2. A Cantilever beam (sensing rod) projecting outward, anchored at one end, will flex in proportion to the weight applied, or removed, at the free end.

Therefore, following Archimedes' Principal, a body (displacer or float) immersed in a fluid experiences a buoyant, or lift force equal to the weight of the displaced fluid. This static lift force acts vertically through the center of gravity of the displaced volume.

Applying the above fundamentals to this liquid level control, we can sense and regulate levels of most gas to fluid interface applications as well as many fluid to fluid interfaces.

By attaching a displacer to the free end of the sensing rod, vertical movement is achieved. The rising and lowering of the fluid gives the static lift force—either up or down, which is transferred along the rod to an actuator pad extending out past the anchored end. As the actuator pad moves to the nozzle, supply pressure is diverted to output, opening a diaphragm-operated motor valve. As fluid is drained, and fluid level declines, the actuator pad moves away from the nozzle and supply pressure is relieved from the diaphragm operated motor valve, and valve closes, allowing the cycle to repeat.

In a throttling mode, this procedure will continually throttle the valve to maintain the fluid level at a desired set point.

In a snap-acting mode, a shuttle pilot is attached to the throttling head converting the throttling output pressure to pilot signal pressure, tripping the shuttle pilot to either full supply pressure, opening valve quickly, or to zero supply pressure, allowing valve to close.

Installation

Before installing this control, inspect the unit for any shipment damage or any foreign material. Visually observe that the actuator pad and rod-end are centered in the sensing rod connector. If not, the unit has been distorted and should be returned to center before placing the control in service.

Check for mechanical clearance of displacer for free movement by flicking the actuator pad after installation of the unit. If vibration is observed, unit is free to work as intended.

Connect suitable supply gas line to the 1/4" FNPT connection stamped "IN". 20 to 30 psi is recommended for proper operation (Filtered gas or air is strongly recommended for better and longer maintenance-free operation.)

Connect "output" port, stamped "OUT" to unit to be controlled.

Start-Up Procedure

Energize the control by opening the supply gas to pilot head (20 to 30 psi recommended).

Adjust the nozzle upward toward the actuator pad, by loosening nozzle lock nut and turning nozzle clockwise, until output pressure gauge starts to indicate a reading (1-3 psi).

Observing the fluid level through the level glasses for desired level, adjust the nozzle up or down to actuate the diaphragm-operated motor valve when desired level is obtained. When satisfactory fluid level is obtained, tighten nozzle lock nut to secure setting.

Observe several cycles to assure that the system is properly functioning.

NOTE: To increase fluid level set-point, adjust the nozzle counter-clockwise away from the actuator pad. To decrease fluid level set-point, adjust nozzle counter-clockwise toward actuator pad.

Normal pilot installation is direct acting, rise in fluid level resulting in an increase of output. For indirect acting, rise in fluid level resulting in a decrease of output, simply loosen 3/4-16 jam nut behind pilot head, and rotate pilot head 180° and retighten 3/4-16 jam nut.

6900 Cantilever Liquid Level Control

Chart 1: Determining the Model Number

MODEL 4C SU-RLC-A01

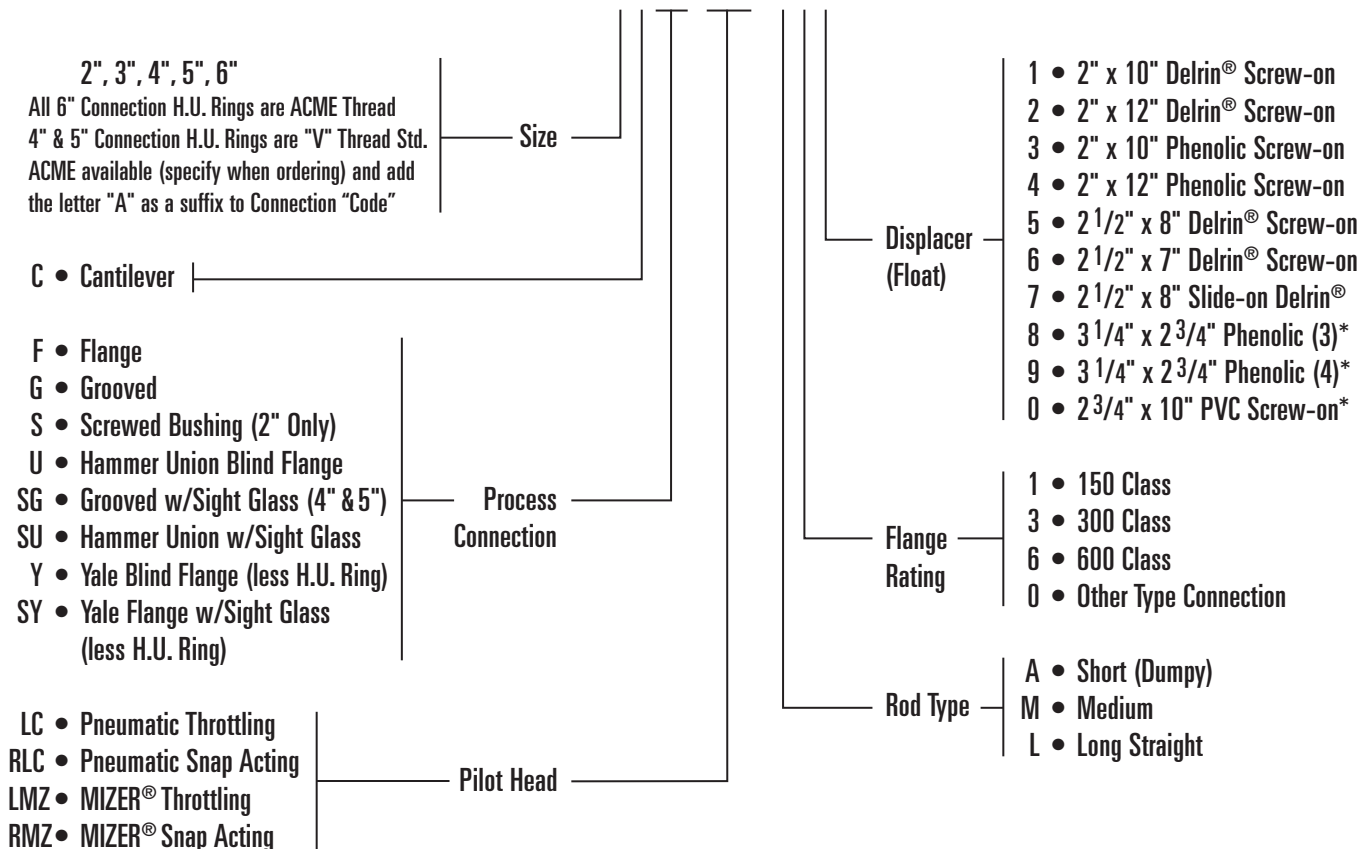

Cantilever Displacers

Displacer Size	Material	Part No.	Max. Temp. Continuous
2" DIA. X 10" SCREW-ON	DELRIN®	05011-1582	200
2" DIA. X 12" SCREW-ON	DELRIN®	05011-1590	200
2" DIA. X 10" SCREW-ON	PHENOLIC	06500-2545	275
2" DIA. X 12" SCREW-ON	PHENOLIC	06500-2537	275
2 1/2" DIA. X 8" SCREW-ON	DELRIN®	30076	200
2 1/2" DIA. X 7" SCREW-ON	DELRIN®	05011-0584	200
2 1/2" O.D. X 8" SLIDE-ON	DELRIN®	05011-0352	200
3 1/4" O.D. X 2 1/4" SLIDE-ON*	PHENOLIC	05010-2342	400
2 3/4" DIA. X 10" SCREW-ON*	PVC	30055	165



DELRIN® & PHENOLIC SCREW-ON DISPLACERS (MEDIUM AND SHORT RODS)

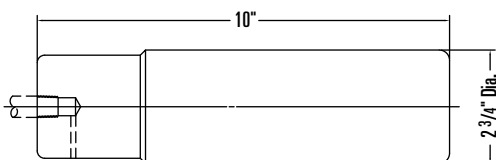

PVC SCREW-ON DISPLACER (MEDIUM AND SHORT RODS)

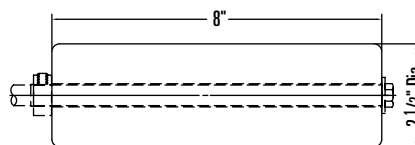

DELRIN® SLIDE-ON DISPLACERS (LONG STRAIGHT ROD ONLY)

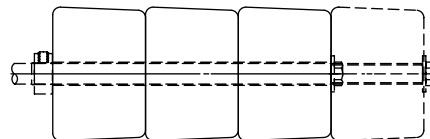

PHENOLIC SLIDE-ON DISPLACERS (LONG STR. & OFFSET ROD)
3 REQ'D LIQUID-GAS INTERFACE • 4 REQ'D LIQUID-LIQUID INTERFACE

*3 Displacers Required for Liquid Gas Interface

*4 Displacers Required for Liquid Liquid Interface

*2 3/4" x 10" Displacer Applicable for Either Liquid Gas or Liquid Liquid Interface
Stainless Steel displacers available. Contact factory.

6900 Cantilever Liquid Level Control

Parts List for Cantilever Snap Acting Pilot Head

Item	Description	Qty.	Part No.
1	PILOT HOUSING, ALUM. ALLOY 383	1	05010-3472
2	STREET "L", MALLEABLE	2	06000-0684
3	PRESSURE GAUGE	2	06000-0700
4	ADJUSTING SCREW, 303 S.S.	1	05010-1674
5	NOZZLE, 303 S.S.	1	05010-1682
6	O-RING, NITRILE	2	05000-0033
7	JAM NUT, 18-8 S.S.	1	05010-2334
8	O-RING, NITRILE	1	05000-0074
9	COVER PLATE, POLYCARBONATE	1	05010-3720
10	COVER SCREW, NYLON	2	05010-3761
11	O-RING, NITRILE	2	05000-0009
12	BOOSTER BODY, ALUMINUM	1	05010-3456
13	COVER, ALUMINUM	1	05010-3464
14	LOWER SEAT, ALUMINUM	1	05010-3423
15	UPPER SEAT, ALUMINUM	1	05010-3431
16	CONNECTOR, ALUMINUM	1	05010-3449
17	SCREW, STEEL PLATED	1	05000-2591
18	SPRING, ASTM A-313	1	05010-3704
19	DIAPHRAGM, FAIRPRENE	1	05010-3712
20	GASKET, FAIRPRENE	1	05010-3696
21	FILLSTER HD. SCREW, STEEL	4	06000-1601
22*	DAMPNER, STAINLESS STEEL	1	05010-3829

*Not Shown

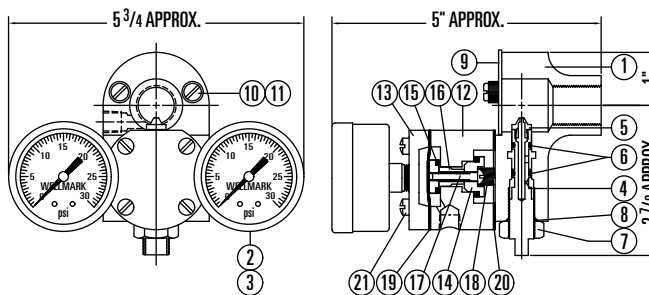

Parts List for Cantilever Throttling Pilot Head

Item	Description	Qty.	Part No.
1	PILOT HOUSING, ALUM. ALLOY 383	1	05010-1617
2	STREET TEE, MALLEABLE	2	06000-0676
3	PRESSURE GAUGE	2	06000-0700
4	ADJUSTING SCREW, 303 S.S.	1	05010-1674
5	NOZZLE, 303 S.S.	1	05010-1682
6	O-RING, NITRILE	2	05000-0033
7	JAM NUT, 18-8 S.S.	1	05010-2334
8	O-RING, NITRILE	1	05000-0074
9	COVER PLATE, POLYCARBONATE	1	05010-3720
10	COVER SCREW, NYLON	2	05010-3761
11	O-RING, NITRILE	2	05000-0009

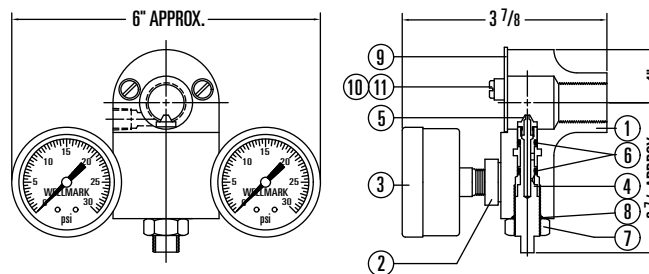

6900 Cantilever Liquid Level Control
Cantilever Rods and Additional Components

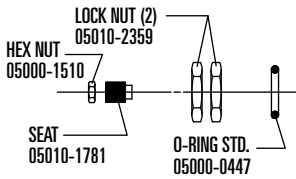

**ADDITIONAL COMPONENTS
FOR ALL RODS**

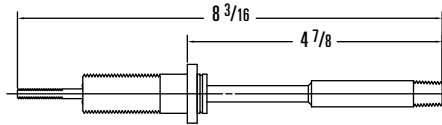

SHORT ROD ASSEMBLY 06500-0630

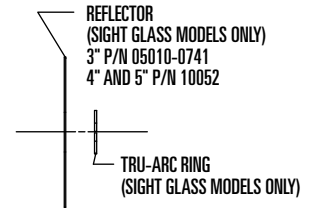

**ADDITIONAL COMPONENTS
FOR ALL RODS**

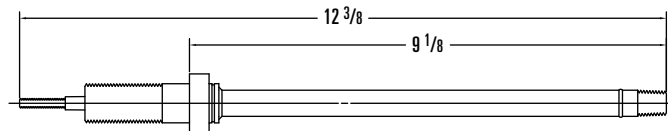

MEDIUM ROD ASSEMBLY 06500-0036

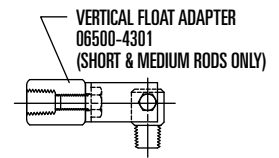

**VERTICAL FLOAT ADAPTER
06500-4301
(SHORT & MEDIUM RODS ONLY)**

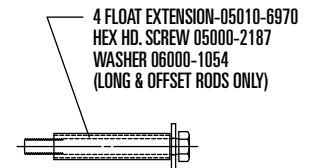

**4 FLOAT EXTENSION-05010-6970
HEX HD. SCREW 05000-2187
WASHER 06000-1054
(LONG & OFFSET RODS ONLY)**

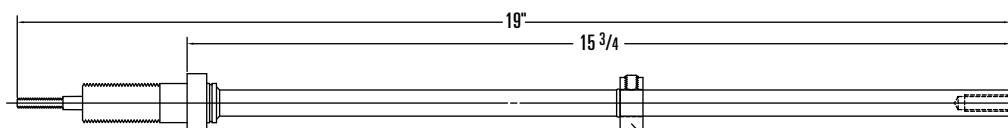

LONG ROD ASSEMBLY 06500-0085



**HEX HD. SCREW-05000-1767
WASHER-06000-1054
(LONG & OFFSET RODS ONLY)**

**COLLAR W/ SCREW
P/N 10059
(LONG ROD ONLY)**

**VERTICAL FLOAT ADAPTER
06500-4285
(LONG & OFFSET RODS ONLY)**

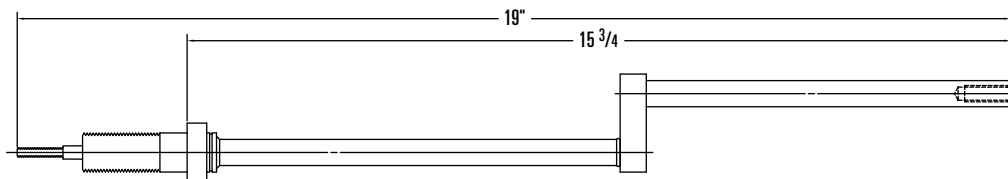

OFFSET ROD ASSEMBLY 06500-0002

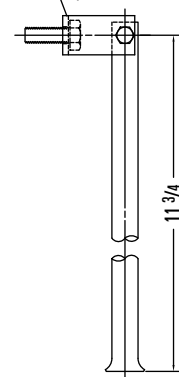

6900 Cantilever Liquid Level Control

Typical Assembly

WARNING
If supply gas is flammable or noxious, this product **MUST** be located in a well ventilated non-hazardous area or sealed and vented to a non-hazardous area.

